



**ANEXO AL INFORME /
ANNEX TO THE REPORT**

1. CARACTERÍSTICAS DEL COMPONENTE ENSAYADO /
TESTED COMPONENT CHARACTERISTICS

Marca / <i>Make</i>	:	
Tipo / <i>Type</i>	:	
Denominación Comercial/ <i>Commercial descriptions</i>	:	LED auto light
Función / <i>Function</i>	:	LED auto light
Tensión nominal / <i>Rated voltage</i>	:	12V y/and 24V
Variante ensayada / <i>Tested variant</i>	:	
Oscilador electrónico de frecuencia superior a 9kHz / <i>Electronic oscillator with frequency greater than 9 kHz</i>	:	SI / YES
Fecha de recepción de la muestra / <i>Sample received on</i>	:	28/02/2020
Modo de operación / <i>Operation mode</i>	:	MO#01 Normal operation

Validate this report with the security code «GKHSSFUM» at: <https://extranet.idiada.com/hom-cve>
Verifique el informe con código de seguridad «GKHSSFUM» en: <https://extranet.idiada.com/hom-cve>

IDIADA CN20030016

* LOS RESULTADOS PRESENTADOS SE REFIEREN ÚNICAMENTE A LA MUESTRA ENSAYADA.
THE PRESENTED RESULTS REFER ONLY TO THE TESTED SAMPLE.
* QUEDA TERMINANTEMENTE PROHIBIDA LA REPRODUCCION PARCIAL DE ESTE INFORME SIN PERMISO EXPRESO DE IDIADA.
THE PARTIAL REPRODUCTION OF THIS REPORT WITHOUT THE PERMISSION OF IDIADA IS COMPLETELY FORBIDDEN.



E9*10R06/00*22229*00

Página / Page 1/3

Comunicación relativa a ⁽¹⁾ / *Communication concerning the* ⁽¹⁾:

- la concesión de una homologación / *approval granted*
- la extensión de una homologación / *approval extended*
- la denegación de una homologación / *approval refused*
- la retirada de una homologación / *approval withdrawn*
- el cese definitivo de una homologación / *production definitely discontinued*

de un tipo de subconjunto eléctrico / electrónico ⁽¹⁾ en aplicación del Reglamento nº 10.06 / *of a type of electrical / electronic sub-assembly* ⁽¹⁾ with regard to ECE Regulation No. 10.06

Nº de homologación / *Type-approval No.*: E9*10R06/00*22229*00

Nº de extensión / *Extension No.*: ---

1. Marca (razón social) / *Make (trade name of manufacturer)*:
2. Tipo y denominación(es) comercial (es) / *Type and general commercial description(s)*:
Tipo / *Type*:
Variantes / *Variants*: Ver documentación técnica / *See technical documentation*
Denominación comercial / *Commercial description*: LED auto light
3. Medio de identificación del tipo, si está marcado en el vehículo, el componente o la unidad técnica independiente ⁽¹⁾ / *Means of identification of type, if marked on the vehicle/component/separate technical unit* ⁽¹⁾: Ver documentación técnica / *See technical documentation*
 - 3.1. Emplazamiento de estas marcas / *Location of that marking*: Ver documentación técnica / *See technical documentation*
4. Categoría de vehículo / *Category of vehicle*: ---
5. Nombre y dirección del fabricante / *Name and address of manufacturer*:
6. Emplazamiento y forma de colocación de la marca de homologación en componentes y unidades técnicas independientes / *In the case of components and separate technical units, location and method of affixing of the approval mark*: Ver documentación técnica / *See technical documentation*
7. Dirección(es) de la(s) planta(s) de montaje / *Address(es) of assembly plant(s)*:
8. Información complementaria (si procede) / *Additional information (where applicable)*: Véase el apéndice / *See appendix*

(1) Tachar lo que no proceda / *Strike out what does not apply*



MINISTERIO
DE INDUSTRIA, COMERCIO Y
TURISMO

DIRECCIÓN GENERAL DE INDUSTRIA Y
DE LA PEQUEÑA Y MEDIANA EMPRESA

SUBDIRECCIÓN GENERAL DE
CALIDAD Y SEGURIDAD INDUSTRIAL



E9*10R06/00*22229*00

Página / Page 2/3

9. Servicio técnico encargado de la realización de los ensayos / *Technical service responsible for carrying out the tests*: IDIADA
10. Fecha del acta de ensayo / *Date of test report*: 05/03/2020
11. Número del acta de ensayo / *Number of test report*: CN20030016
12. Observaciones (si las hubiera) / *Remarks (if any)*: Véase el apéndice / *See appendix*
13. Lugar / *Place*: Madrid
14. Fecha / *Date*: Ver firma electrónica / *See digital signature*
15. Firma / *Signature*:

EL SUBDIRECTOR GENERAL DE CALIDAD Y SEGURIDAD INDUSTRIAL
Resolución P.D. del DIRECTOR GENERAL DE INDUSTRIA Y DE LA PYME de 25-10-2012
16. Se adjunta el índice del expediente de homologación en posesión de las autoridades competentes, la cual puede obtenerse a petición del interesado / *The index to the information package lodged with the approval authority, which may be obtained on request is attached*
17. Motivos de extensión / *Reasons for extension*: ----

(1) Tachar lo que no proceda / *Strike out what does not apply*

FIRMADO



E9*10R06/00*22229*00

Página / Page 3/3

**Apéndice del certificado de homologación N° E9*10R06/00*22229*00
relativo a la homologación de subconjuntos eléctricos o electrónicos en lo que se refiere al Reglamento N°10**

*Appendix to Type-approval communication form N° E9*10R06/00*22229*00
concerning the type-approval of an electrical/electronic sub-assembly under Regulation N° 10*

1. Información adicional / *Additional information (where applicable):*
 - 1.1. Tensión nominal del sistema eléctrico / *Electrical system rated voltage: Ver documentación técnica / See technical documentation*
 - 1.2. Este SEE puede utilizarse en todos los vehículos con las siguientes restricciones / *This ESA can be used on any vehicle type with the following restrictions: SI / Yes*
 - 1.2.1. Condiciones de instalación, si las hubiera / *Installation conditions, if any: ---*
 - 1.3. Este SEE sólo puede utilizarse en los tipos de vehículo siguientes / *This ESA can only be used on the following vehicle types: ---*
 - 1.3.1. Condiciones de instalación si las hubiera / *Installation conditions, if any: ---*
 - 1.4. El método o métodos específicos de ensayo utilizados y los márgenes de frecuencias abarcados para determinar la inmunidad han sido / *The specific test method(s) used and the frequency ranges covered to determine immunity were: Ver informe de ensayo n° / See test report No. CN20030016*
 - 1.5. Servicio técnico acreditado según ISO 17025 y reconocido por el organismo homologador responsable de realizar los ensayos/ *Technical service accredited to ISO 17025 and recognized by the Approval Authority responsible for carrying out the tests: IDIADA*
2. Observaciones/ *Remarks (if any): ---*

(1) Tachar lo que no proceda / *Strike out what does not apply*

**INFORME Nº / REPORT No. CN20030016****REGLAMENTO CEPE/ONU 10R06 REFERENTE A LA COMPATIBILIDAD ELECTROMAGNÉTICA
UN/ECE REGULATION 10R06 RELATING ELECTROMAGNETIC COMPATIBILITY**

Solicitante / Applicant : _____

Fabricante / Manufacturer : _____

Marca / Make : _____

Tipo / Type : _____

Variantes / Variants : Ver documentación técnica / See technical documentation

Denominación comercial /
Commercial description : LED auto light

Categoría / Category : Componente / Component

Lugar y fecha de emisión del informe /
Place and date of test report issue : L'Albornar, Santa Oliva (Tarragona), 05/03/2020

CONCLUSIONES: Este componente CUMPLE con las prescripciones sobre compatibilidad electromagnética relativo al REGLAMENTO CEPE/ONU 10R06, como se detalla en el anexo a este informe. /
CONCLUSIONS: This component FULFILLS the prescriptions about electromagnetic compatibility, in application to UN/ECE REGULATION 10R06, as detailed in the annex to this report.

Realizado / Performed by:

Juxiang(lyrica) Chen
INGENIERO DE HOMOLOGACIONES
HOMOLOGATION ENGINEER

Vº.Bº. / Revised by:

Lluís Sans Gomis
JEFE DE DEPARTAMENTO
DEPARTMENT MANAGER

- * LOS RESULTADOS PRESENTADOS SE REFIEREN ÚNICAMENTE A LA MUESTRA ENSAYADA.
THE PRESENTED RESULTS REFER ONLY TO THE TESTED SAMPLE.
- * QUEDA TERMINANTEMENTE PROHIBIDA LA REPRODUCCION PARCIAL DE ESTE INFORME SIN PERMISO EXPRESO DE IDIADA.
THE PARTIAL REPRODUCTION OF THIS REPORT WITHOUT THE PERMISSION OF IDIADA IS COMPLETELY FORBIDDEN.



2. ENSAYOS DE RADIACIÓN ELECTROMAGNÉTICA / ELECTROMAGNETIC RADIATION TEST

2.1 Ensayo de radiación electromagnética de banda ancha / Broadband electromagnetic radiation test

Método de ensayo / <i>Test method</i>	:	Indoor / Outdoor
Condiciones del lugar de ensayo / <i>Test place conditions</i>	:	Según el anexo 7 / <i>According to Annex 7</i>
Detectores de la antena receptora / <i>Receiving antenna detectors</i>	:	Cresta / Quasi-cresta <i>Peak / Quasi peak</i>
Componente en estado normal de funcionamiento / <i>Component at normal operating</i>	:	SI / YES
Ancho de banda / <i>Bandwidth</i>	:	120 kHz
Resultados de ensayo / <i>Test Results</i>	:	Ver página 4 a 6 / <i>See page 4 to 6</i>

CORRECTO / CORRECT

2.2 Ensayos de Banda Estrecha / Narrowband electromagnetic radiation test

Método de ensayo / <i>Test method</i>	:	Indoor / Outdoor
Condiciones del lugar de ensayo / <i>Test place conditions</i>	:	Según el anexo 8 / <i>According to the Annex 8</i>
Detectores de la antena receptora / <i>Receiving antenna detectors</i>	:	Cresta / Media <i>Peak / Average</i>
Componente en estado normal de funcionamiento / <i>Component at normal operating</i>	:	SI / YES
Ancho de banda / <i>Bandwidth</i>	:	120 kHz
Resultados de ensayo / <i>Test Results</i>	:	Ver página 4 a 6 / <i>See page 4 to 6</i>

CORRECTO / CORRECT

* LOS RESULTADOS PRESENTADOS SE REPIEREN ÚNICAMENTE A LA MUESTRA ENSAYADA.
 THE PRESENTED RESULTS REFER ONLY TO THE TESTED SAMPLE.

* QUEDA TERMINANTEMENTE PROHIBIDA LA REPRODUCCIÓN PARCIAL DE ESTE INFORME SIN PERMISO EXPRESO DE IDIADA.
 THE PARTIAL REPRODUCTION OF THIS REPORT WITHOUT THE PERMISSION OF IDIADA IS COMPLETELY FORBIDDEN.



Slow Pulse: OFF-->ON Data Graph

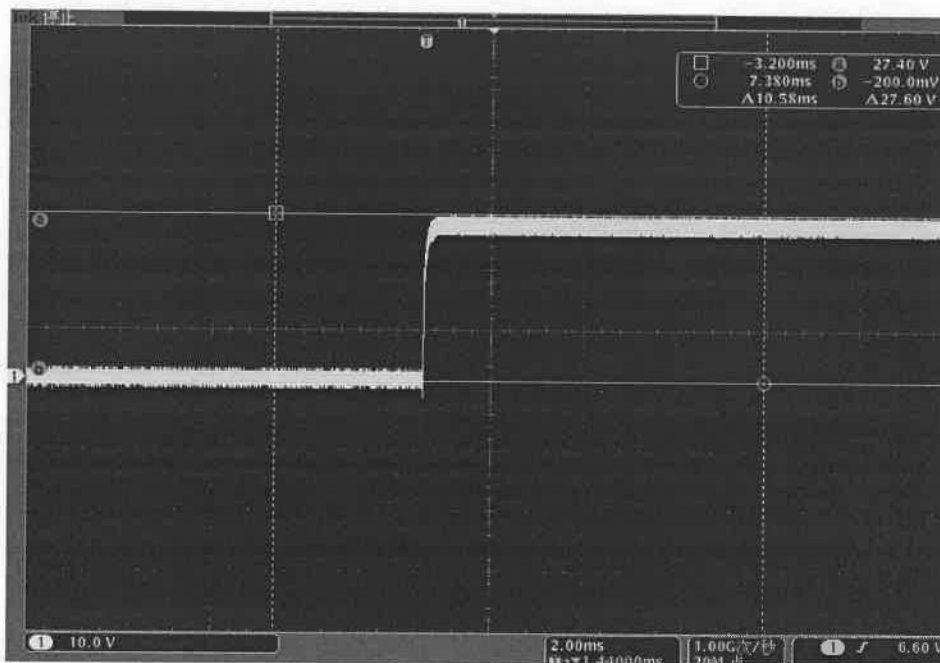

Slow Pulse: ON-->OFF Data Graph

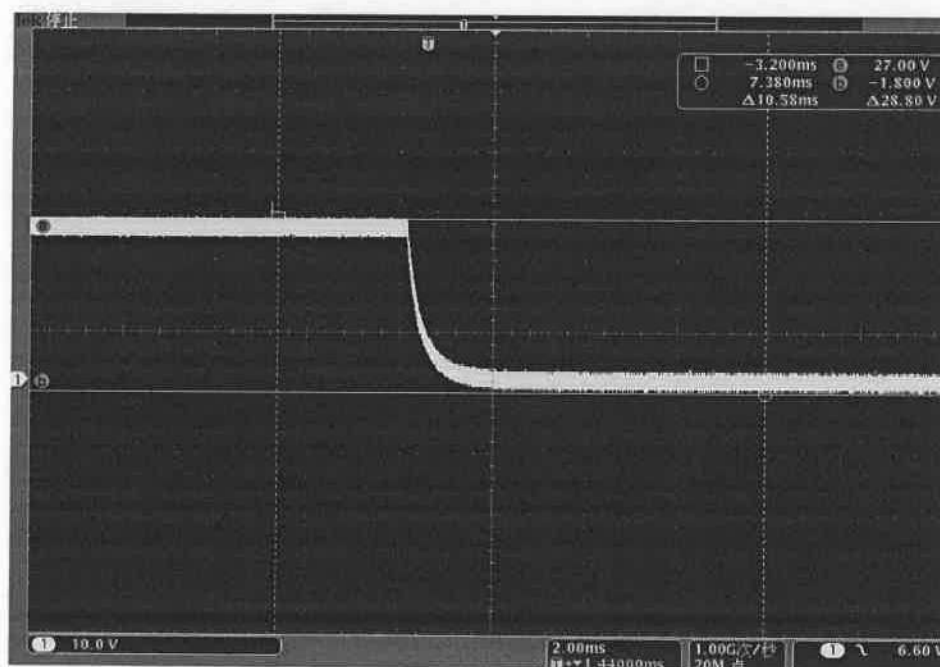

Validato this report with the security code «GKI15SFUM» at: <https://extranet.idiada.com/hom-cve>
Verifique el informe con código de seguridad «GKI15SFUM» en: <https://extranet.idiada.com/hom-cve>

IDIADA CN20030016

* LOS RESULTADOS PRESENTADOS SE REFIEREN UNICAMENTE A LA MUESTRA ENSAYADA.
 THE PRESENTED RESULTS REFER ONLY TO THE TESTED SAMPLE.
 * QUEDA TERMINANTEMENTE PROHIBIDA LA REPRODUCCION PARCIAL DE ESTE INFORME SIN PERMISO EXPRESO DE IDIADA.
 THE PARTIAL REPRODUCTION OF THIS REPORT WITHOUT THE PERMISSION OF IDIADA IS COMPLETELY FORBIDDEN.



2.3 Resultado de ensayo / Test Results

24V del SEE como el caso más desfavorable / 24V of the ESA as the worst case

MO#01 Normal Mode

Banda Ancha y Banda Estrecha / Broadband and Narrowband - Polarización Horizontal / Horizontal Polarisation 30MHz to 1GHz

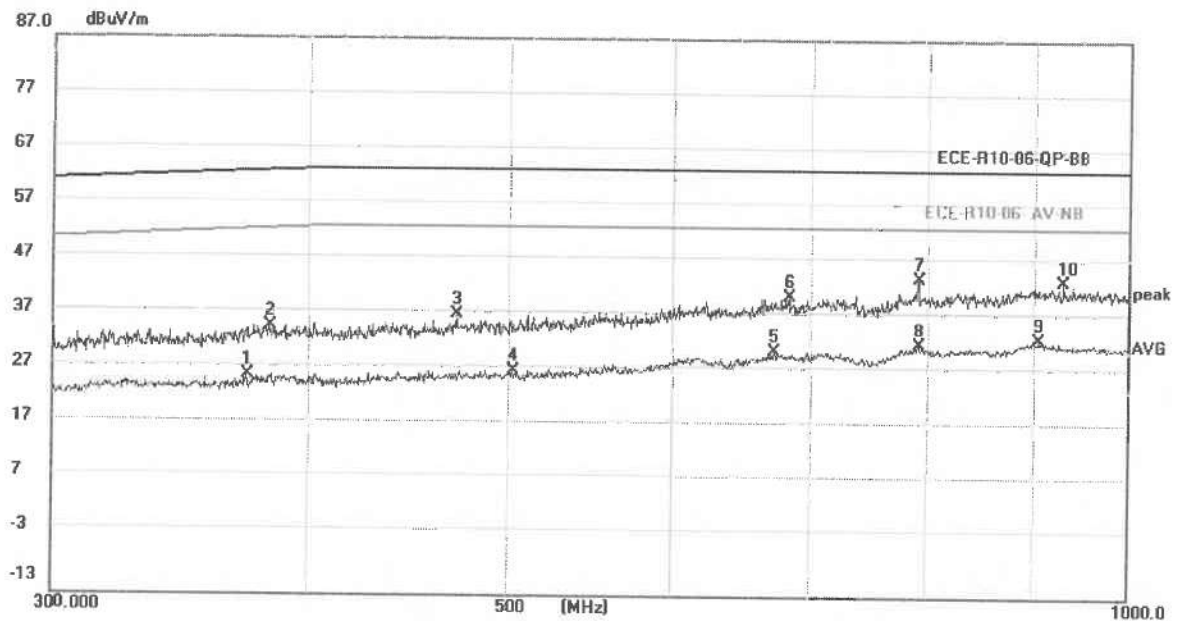
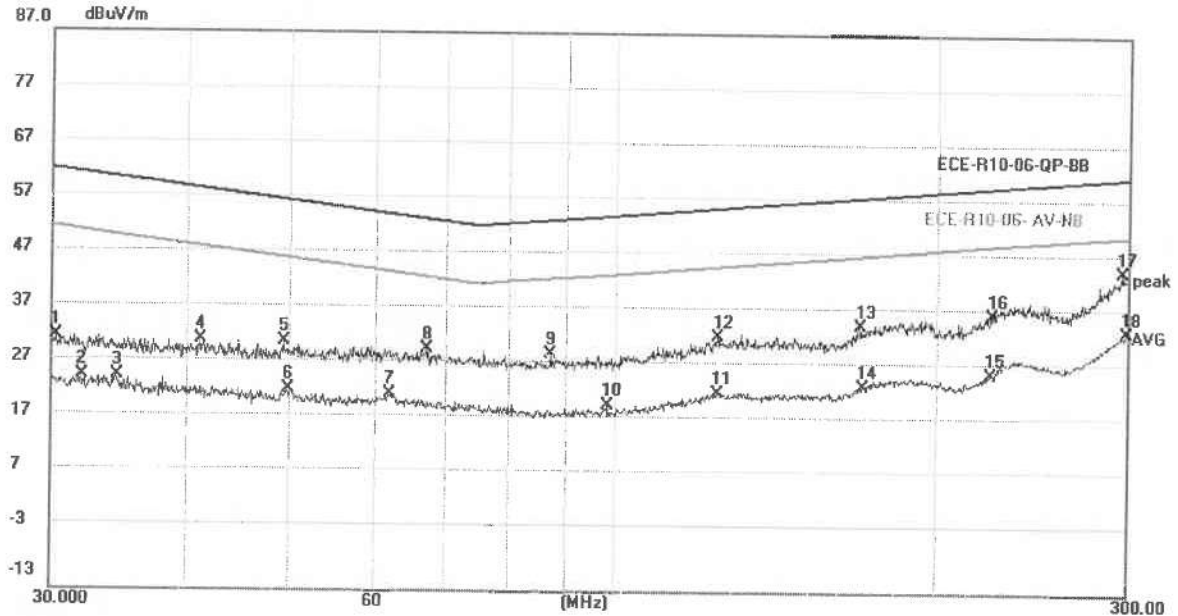

Validate this report with the security code «GKH5SFUM» at: <https://extranet.idiada.com/hom-cve>
Verifique el informe con código de seguridad «GKH5SFUM» en: <https://extranet.idiada.com/hom-cve>

CN20030016

IDIADA

* LOS RESULTADOS PRESENTADOS SE REFIEREN ÚNICAMENTE A LA MUESTRA ENSAYADA.

THE PRESENTED RESULTS REFER ONLY TO THE TESTED SAMPLE.

* QUEDA TERMINANTEMENTE PROHIBIDA LA REPRODUCCIÓN PARCIAL DE ESTE INFORME SIN PERMISO EXPRESO DE IDIADA.
THE PARTIAL REPRODUCTION OF THIS REPORT WITHOUT THE PERMISSION OF IDIADA IS COMPLETELY FORBIDDEN.



Banda Ancha y Banda Estrecha / *Broadband and Narrowband* - Polarización Vertical / *Vertical Polarisation* 30MHz to 1GHz

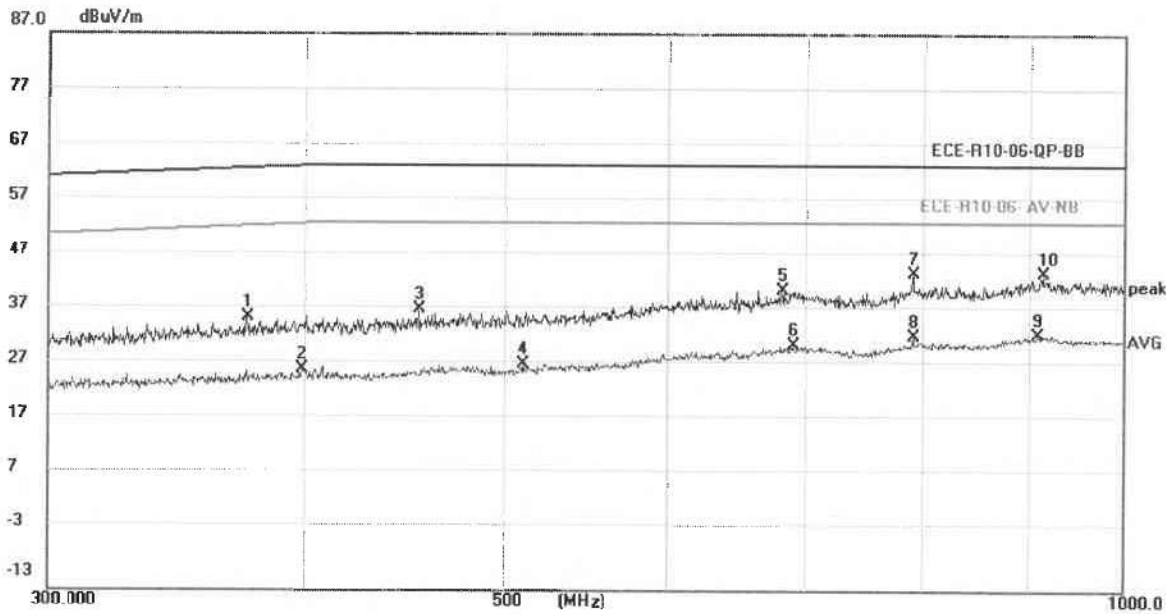
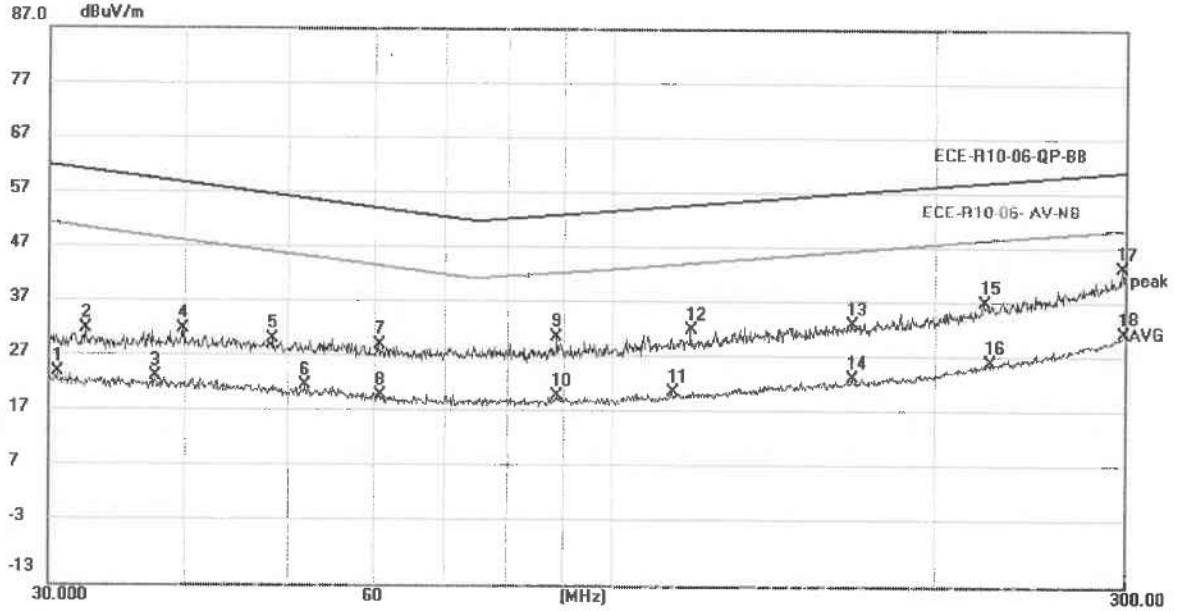

Validate this report with the security code «GK1ISSFUM» at: <https://extranet.idiada.com/hom-cve>
Verifique el informe con código de seguridad «GK1ISSFUM» en: <https://extranet.idiada.com/hom-cve>

CN20030016

* LOS RESULTADOS PRESENTADOS SE REFIEREN ÚNICAMENTE A LA MUESTRA ENSAYADA.
THE PRESENTED RESULTS REFER ONLY TO THE TESTED SAMPLE.

* QUEDA TERMINANTEMENTE PROHIBIDA LA REPRODUCCION PARCIAL DE ESTE INFORME SIN PERMISO EXPRESO DE IDIADA.
THE PARTIAL REPRODUCTION OF THIS REPORT WITHOUT THE PERMISSION OF IDIADA IS COMPLETELY FORBIDDEN.

**BANDA ANCHA / BROADBAND**

Detector: Quasi Peak detector

MO#01 Normal Mode

Reference (MHz)	Apply (MHz)		Results (dB μ V/m)			Limit (dB μ V/m) (QP)
	Horizontal	Vertical	Horizontal	Vertical	Maximum	
30-34	30.28	32.44	32.3	32.75	32.75	62.00-60.63
34-45	41.13	39.91	31.67	32.77	32.77	60.63-57.57
45-60	49.33	48.32	31.48	31.11	31.48	57.57-54.44
60-80	67.16	60.69	30.14	29.93	30.14	54.44-52.42
80-100	87.32	88.94	29.43	31.42	31.42	52.42-53.89
100-130	124.49	117.79	32.8	32.84	32.84	53.89-55.61
130-170	169.09	167.16	34.84	33.82	34.84	55.61-57.38
170-225	224.97	221.88	36.85	37.87	37.87	57.38-59.22
225-300	297.25	298.62	44.56	44.1	44.56	59.22-61.11
300-400	382.14	374.40	35.28	36.11	36.11	61.11-63.00
400-525	471.76	453.93	37.6	37.49	37.6	63.00
525-700	682.73	681.09	41.05	41.13	41.13	63.00
700-850	790.75	790.75	44.31	44.01	44.31	63.00
850-1000	930.31	914.76	43.8	43.99	43.99	63.00

BANDA ESTRECHA / NARROWBAND

Detector: Average detector

MO#01 Normal Mode

Reference (MHz)	Apply (MHz)		Results (dB μ V/m)			Limit (dB μ V/m) (AV)
	Horizontal	Vertical	Horizontal	Vertical	Maximum	
30-34	31.92	30.56	25.23	24.95	25.23	52.00-50.63
34-45	34.37	37.59	25.25	24.27	25.25	50.63-47.57
45-60	49.67	51.78	22.95	22.8	22.95	47.57-44.44
60-80	61.82	60.69	22.16	20.95	22.16	44.44-42.42
80-100	98.20	88.94	20.39	20.84	20.84	42.42-43.89
100-130	124.20	113.27	22.81	21.78	22.81	43.89-45.61
130-170	169.87	167.16	23.96	24.16	24.16	45.61-47.38
170-225	223.93	224.45	26.12	27.1	27.1	47.38-49.22
225-300	299.31	299.31	33.62	32.17	33.62	49.22-51.11
300-400	372.60	398.58	26.47	26.63	26.63	51.11-53.00
400-525	501.64	510.17	27.55	27.77	27.77	53.00
525-700	671.32	690.17	31.34	31.32	31.34	53.00
700-850	790.75	790.75	32.56	32.72	32.72	53.00
850-1000	905.99	909.27	33.45	33.06	33.45	53.00

* LOS RESULTADOS PRESENTADOS SE REFIEREN ÚNICAMENTE A LA MUESTRA ENSAYADA.
THE PRESENTED RESULTS REFER ONLY TO THE TESTED SAMPLE.

* QUEDA TERMINANTEMENTE PROHIBIDA LA REPRODUCCION PARCIAL DE ESTE INFORME SIN PERMISO EXPRESO DE IDIADA.
THE PARTIAL REPRODUCTION OF THIS REPORT WITHOUT THE PERMISSION OF IDIADA IS COMPLETELY FORBIDDEN.



3. INMUNIDAD Y EMISIONES DE PERTURBACIONES CONDUCCIDAS / IMMUNITY AND EMISSION OF CONDUCTED DISTURBANCES TEST

3.1. **Emisiones de perturbaciones conducidas / Emissions of conducted disturbances**

- Método de ensayo / Test method : Según el Anexo 10 del Reglamento ECE 10.06
According to Annex 10 of ECE Regulation 10.06
- Temperatura de ensayo / Test temperature : 25 ° C
- Tensión de alimentación de ensayo / Test voltage : DC 13.5V y/and DC 27 V
- Condiciones de medida / Measuring Condition : Comprobación de la emisión de transitorios producidos en el interruptor de ENC / DESC hacia las líneas de alimentación / Check transient emission at switch ON/OFF in Power Source lines
- Gráficas de resultados / Results charts : Ver página 8 a 11 / See page 8 to 11
- Resultado de ensayo / Test Result :

Polaridad de la amplitud del impulso/ Polarity of pulse amplitude	Amplitud máxima de pulso permitido para/ Maximum allowed pulse amplitude for	Tipo de pulso / Type of pulse	Resultado de ensayo / Test result
	Vehículos con sistemas a 12V / Vehicles with 12 V systems		
Positivo/ Positive	+ 75	Lento / Slow	Cumple / Fulfils
		Rápido / Fast	Cumple / Fulfils
Negativo/ Negative	- 100	Lento / Slow	Cumple / Fulfils
		Rápido / Fast	Cumple / Fulfils

CORRECTO / CORRECT

Polaridad de la amplitud del impulso/ Polarity of pulse amplitude	Amplitud máxima de pulso permitido para/ Maximum allowed pulse amplitude for	Tipo de pulso / Type of pulse	Resultado de ensayo / Test result
	Vehículos con sistemas a 24V / Vehicles with 24 V systems		
Positivo/ Positive	+150	Lento / Slow	Cumple / Fulfils
		Rápido / Fast	Cumple / Fulfils
Negativo/ Negative	-450	Lento / Slow	Cumple / Fulfils
		Rápido / Fast	Cumple / Fulfils

CORRECTO / CORRECT

* LOS RESULTADOS PRESENTADOS SE REFIEREN ÚNICAMENTE A LA MUESTRA ENSAYADA.
THE PRESENTED RESULTS REFER ONLY TO THE TESTED SAMPLE.

* QUEDA TERMINANTEMENTE PROHIBIDA LA REPRODUCCION PARCIAL DE ESTE INFORME SIN PERMISO EXPRESO DE IDIADA.
THE PARTIAL REPRODUCTION OF THIS REPORT WITHOUT THE PERMISSION OF IDIADA IS COMPLETELY FORBIDDEN.



Slow Pulse: OFF-->ON Data Graph

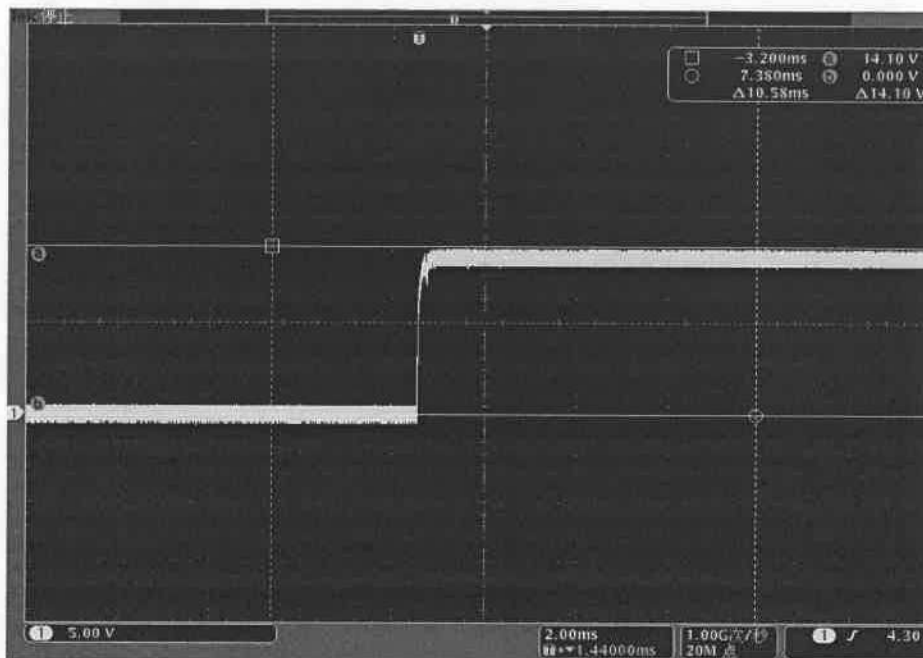

Slow Pulse: ON-->OFF Data Graph

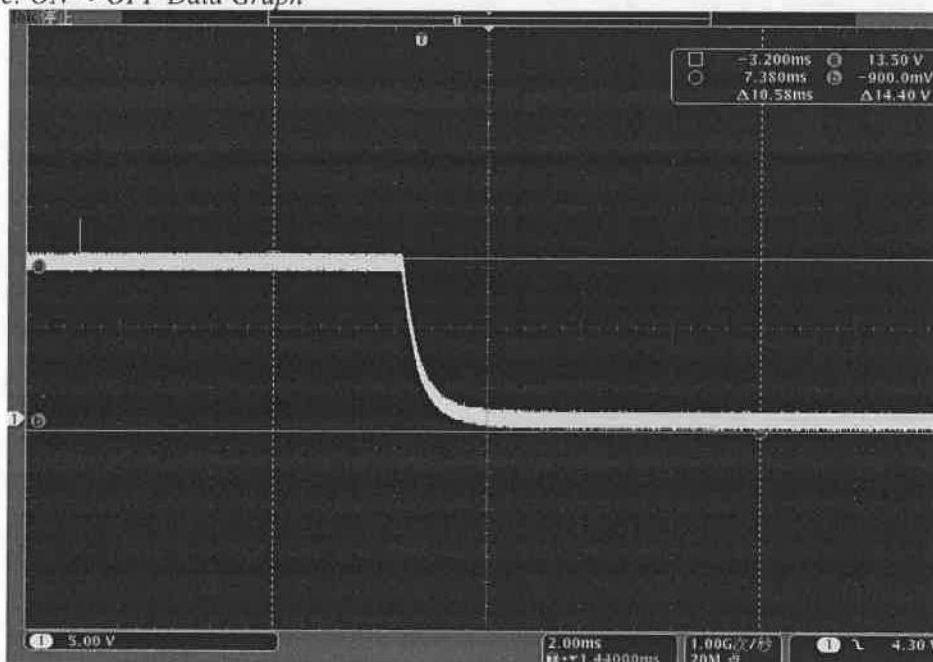

Validate this report with the security code «GKHSS5FUM» at: <https://extranet.idiada.com/from-cve>
Verifique el informe con código de seguridad «GKHSS5FUM» en: <https://extranet.idiada.com/from-cve>

IDIADA CN20030016

- * LOS RESULTADOS PRESENTADOS SE REFIEREN ÚNICAMENTE A LA MUESTRA ENSAYADA.
THE PRESENTED RESULTS REFER ONLY TO THE TESTED SAMPLE.
- * QUEDA TERMINANTEMENTE PROHIBIDA LA REPRODUCCION PARCIAL DE ESTE INFORME SIN PERMISO EXPRESO DE IDIADA.
THE PARTIAL REPRODUCTION OF THIS REPORT WITHOUT THE PERMISSION OF IDIADA IS COMPLETELY FORBIDDEN.



Fast Pulse: OFF-->ON Data Graph

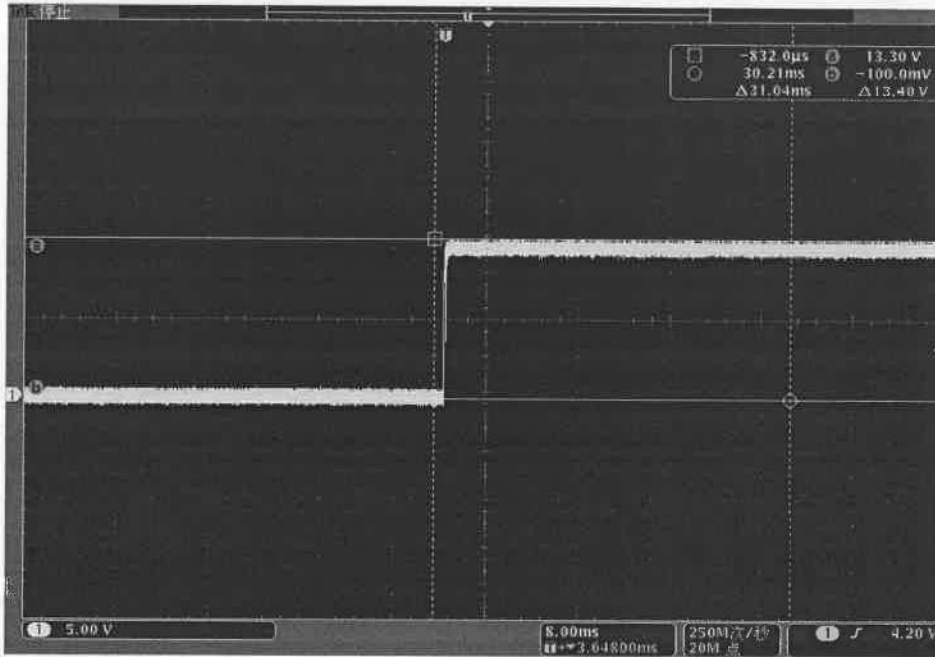

Fast Pulse: ON-->OFF Data Graph

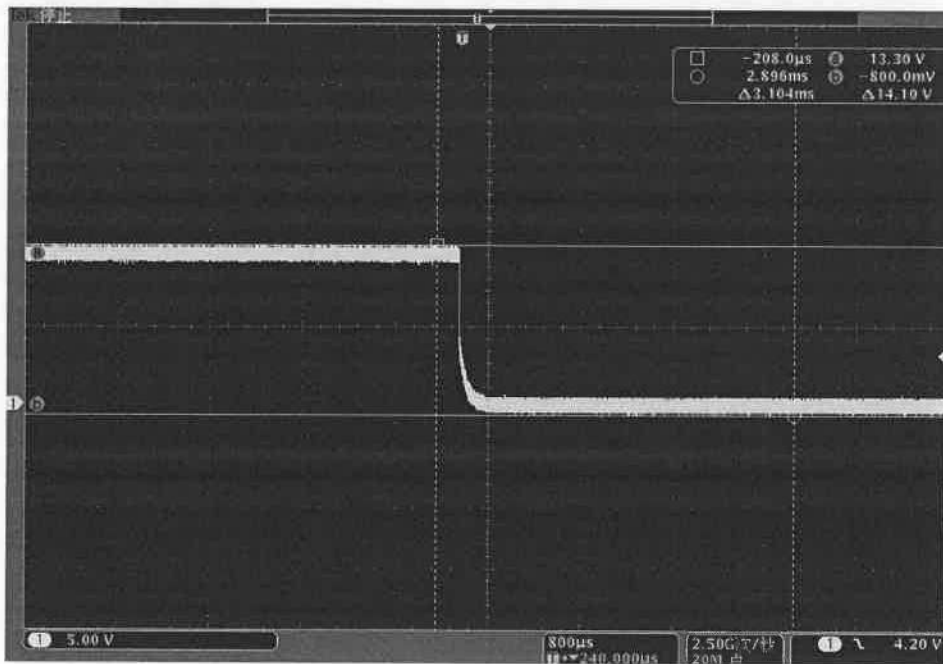

Validate this report with the security code «GKHSSFFUM» at: <https://extranet.idiada.com/home-cve>
Verifique el informe con código de seguridad «GKHSSFFUM» en: <https://extranet.idiada.com/home-cve>

CN20030016

IDIADA

* LOS RESULTADOS PRESENTADOS SE REFIEREN ÚNICAMENTE A LA MUESTRA ENSAYADA.
 THE PRESENTED RESULTS REFER ONLY TO THE TESTED SAMPLE.
 * QUEDA TERMINANTEMENTE PROHIBIDA LA REPRODUCCION PARCIAL DE ESTE INFORME SIN PERMISO EXPRESO DE IDIADA.
 THE PARTIAL REPRODUCTION OF THIS REPORT WITHOUT THE PERMISSION OF IDIADA IS COMPLETELY FORBIDDEN.



Fast Pulse: OFF-->ON Data Graph

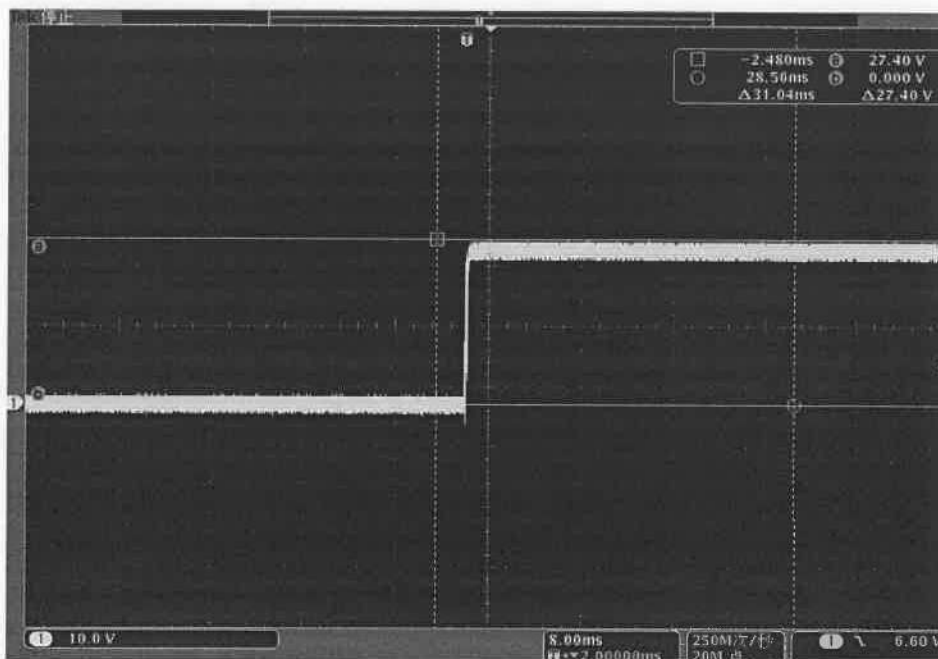

Fast Pulse: ON-->OFF Data Graph

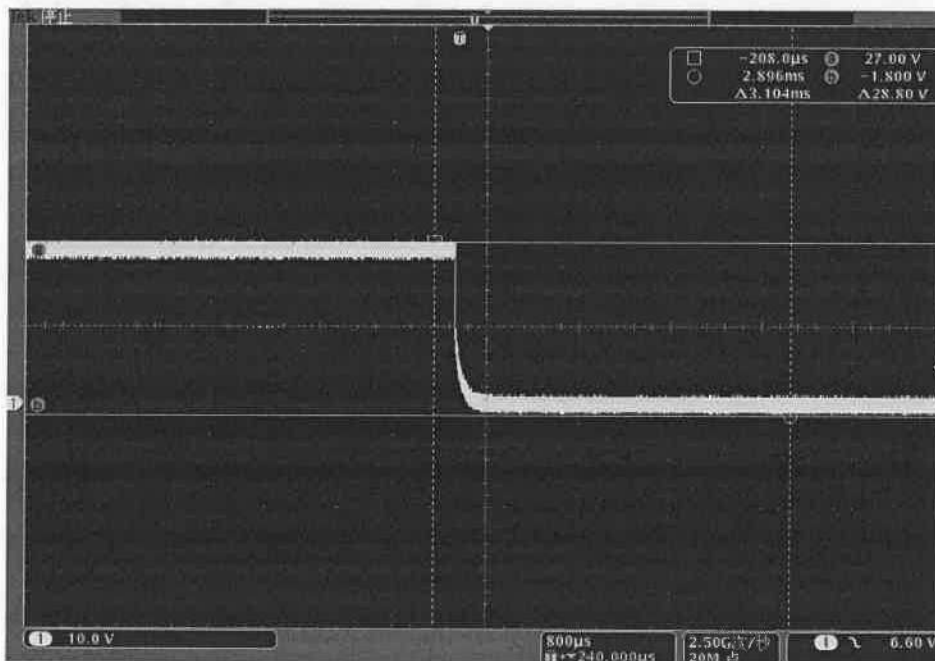

Validate this report with the security code «GKIHSFUM» at: <https://extranet.idiada.com/home-cve>
Verifique el informe con código de seguridad «GKIHSFUM» en: <https://extranet.idiada.com/home-cve>

IDIADA CN20030016

- * LOS RESULTADOS PRESENTADOS SE REFIEREN ÚNICAMENTE A LA MUESTRA ENSAYADA.
THE PRESENTED RESULTS REFER ONLY TO THE TESTED SAMPLE.
- * QUEDA TERMINANTEMENTE PROHIBIDA LA REPRODUCCION PARCIAL DE ESTE INFORME SIN PERMISO EXPRESO DE IDIADA.
THE PARTIAL REPRODUCTION OF THIS REPORT WITHOUT THE PERMISSION OF IDIADA IS COMPLETELY FORBIDDEN.



Ficha de características nº 1
según Reglamento ECE R10.06
*Information document no. 1
as per Regulation ECE R10.06*
Feb. 2020 / Feb. 2020
Página / Page 2

INDICE / INDEX

2	Índice / <i>Index</i>
3	Generalidades / <i>General</i>
5	Planos del SEE / <i>Drawings of the ESA</i>
6	Diagrama de bloques electrónicos / <i>Electronic block diagram</i>
7	Lista de componentes del SEE / <i>List of components constituting the ESA</i>



3.2. Inmunidad a las perturbaciones transitorias conducidas a lo largo de las líneas de alimentación / Immunity against disturbances conducted along supply lines

Método de ensayo / Test method : Según el Anexo 10 del Reglamento ECE 10.06
According to Annex 10 of ECE Regulation 10.06

Estado de funcionamiento para el sistema / Performance criteria

Pulso/ Pulse	Nivel de inmunidad/ Immunity level	Estado de funcionamiento para el sistema/ Performance criteria	
		Relacionados con funciones de inmunidad/ Related to immunity functions	No relacionados con funciones de inmunidad/ Not related to immunity functions
1	III	C	D
2a	III	B	D
2b	III	C	D
3a/3b	III	A	D
4	III	B /or C	D

Resultado de ensayo/ Test Result

(immunity related function)
MO#01

Vehículos con sistemas a 12V / Vehicles with 12 V systems

Pulso/ Pulse	Nivel III de inmunidad / Immunity Level III	Ciclo de ráfaga/ Tiempo de repetición del pulso Duration	Tiempo de ensayo/ Nº de pulsos Test time/ N° of pulses	Resultado del ensayo / Test result
1	-75 V	Ri=10Ω, td=2ms, tr=1μs, t1=1s, t2=200ms, t3<100μs	5000 pulsos/ pulses	C
2a	+37 V	Ri=2Ω, td=0.05ms, tr=1μs, t1=5s	5000 pulsos/ pulses	A
2b	+10 V	Ri=0Ω, td=1s, t12=1ms, tr=1ms, t6=1ms	10 pulsos/ pulses	C
3a	-112 V	Ri=50Ω, td=0.1μs, tf=5ns, t1=100μs, t4=10ms, t5=90ms	1 h	A
3b	+75 V	Ri=50Ω, td=0.1μs, tr=5ns, t1=100μs, t4=10ms, t5=90ms	1 h	A
4	-6V	Va=-2.5V, Ri=0Ω, t8<50ms, t9=10s, t10=5ms, t11=5ms to 100ms	1 pulso/ pulse	C

CORRECTO / CORRECT

Validate this report with the security code «GKH5SFUM» at: <https://extranet.idiada.com/rom-cve>
Verifique el informe con código de seguridad «GKH5SFUM» en: <https://extranet.idiada.com/rom-cve>

IDIADA CN20030016

* LOS RESULTADOS PRESENTADOS SE REFIEREN UNICAMENTE A LA MUESTRA ENSAYADA.
THE PRESENTED RESULTS REFER ONLY TO THE TESTED SAMPLE.
* QUEDA TERMINANTEMENTE PROHIBIDA LA REPRODUCCION PARCIAL DE ESTE INFORME SIN PERMISO EXPRESO DE IDIADA.
THE PARTIAL REPRODUCTION OF THIS REPORT WITHOUT THE PERMISSION OF IDIADA IS COMPLETELY FORBIDDEN.



Vehículos con sistemas a 24V / Vehicles with 24 V systems

Pulso/ Pulse	Nivel III de inmunidad / Immunity Level III	Ciclo de ráfaga/ Tiempo de repetición del pulso Duration	Tiempo de ensayo/ Nº de pulsos Test time/ N° of pulses	Resultado del ensayo / Test result
1	-450 V	Ri=50Ω, td=1ms, tr=3μs, t1=1s, t2=200ms, t3<100μs	5000 pulsos/ pulses	C
2a	+37 V	Ri=2Ω, td=0.05ms, tr=1μs, t1=5s	5000 pulsos/ pulses	A
2b	+20 V	Ri=0Ω, td=1s, t12=1ms, tr=1ms, t6=1ms	10 pulsos/ pulses	C
3a	-150 V	Ri=50Ω, td=0.1μs, tf=5ns, t1=100μs, t4=10ms, t5=90ms	1 h	A
3b	+150 V	Ri=50Ω, td=0.1μs, tr=5ns, t1=100μs, t4=10ms, t5=90ms	1 h	A
4	-12 V	Va=-12V, Ri=0Ω, t8<50ms, t9=10s, t10=10ms, t11=10ms to 100ms	1 pulso/ pulse	C

CORRECTO / CORRECT

Validate this report with the security code «GKI-SS-FUM» at: <https://extranet.idiada.com/hom-cve>
 Verifique el informe con código de seguridad «GKI-SS-FUM» en: <https://extranet.idiada.com/hom-cve>

CN20030016

IDIADA

* LOS RESULTADOS PRESENTADOS SE REFIEREN ÚNICAMENTE A LA MUESTRA ENSAYADA.
 THE PRESENTED RESULTS REFER ONLY TO THE TESTED SAMPLE.
 * QUEDA TERMINANTEMENTE PROHIBIDA LA REPRODUCCION PARCIAL DE ESTE INFORME SIN PERMISO EXPRESO DE IDIADA.
 THE PARTIAL REPRODUCTION OF THIS REPORT WITHOUT THE PERMISSION OF IDIADA IS COMPLETELY FORBIDDEN.



4. ENSAYO DE INMUNIDAD ELECTROMAGNÉTICA / ELECTROMAGNETIC IMMUNITY TEST

Método de ensayo / <i>Test method</i>	: Según el Anexo 9 del Reglamento ECE 10.06 <i>According to Annex 9 of ECE Regulation 10.06</i>
Frecuencias / <i>Frequencies</i>	: 20 – 400MHz (BCI) , 400 – 2000 MHz (Free Field (ALSE))
Nivel de campo / <i>Level of field</i>	: 60 mA, 30 V/m
Modulación / <i>Modulation</i>	: AM 1 KHz 80% (20 – 800 MHz), PM 217 Hz 12.5 % (800 – 2000 MHz)
Resultado de ensayo/ <i>Test Result</i>	: No se detectan fallos / <i>No failures detected</i>

CORRECTO / CORRECT

Lugar de ensayo / *Test place*: Guangzhou, China
Fecha de ensayo / *Test date*: 02/03/2020

Validate this report with the security code «GKI1S5FUM» at: <https://extranet.idiada.com/from-cve>
Verifique el informe con código de seguridad «GKI1S5FUM» en: <https://extranet.idiada.com/from-cve>

CN20030016

Juxiang(lyrica) Chen
INGENIERO DE HOMOLOGACIONES
HOMOLOGATION ENGINEER

* LOS RESULTADOS PRESENTADOS SE REFIEREN ÚNICAMENTE A LA MUESTRA ENSAYADA.
THE PRESENTED RESULTS REFER ONLY TO THE TESTED SAMPLE.
* QUEDA TERMINANTEMENTE PROHIBIDA LA REPRODUCCION PARCIAL DE ESTE INFORME SIN PERMISO EXPRESO DE IDIADA.
THE PARTIAL REPRODUCTION OF THIS REPORT WITHOUT THE PERMISSION OF IDIADA IS COMPLETELY FORBIDDEN.

IDIADA

DOCUMENTACIÓN TÉCNICA /
TECHNICAL DOCUMENTATION

IDIADA CN20030016



(Hanma), TOTRON

Ficha de características nº HML-5148 Series relativa a la homologación de tipo CE de subconjuntos eléctricos o electrónicos respecto a la compatibilidad electromagnética(Reglamento ECE 10 cuya última modificación la constituye la serie de enmiendas 06)

Information document no.HML-5148 Series relating to EC type-approval of an electric/electronic subassembly with respect to electromagnetic compatibility (Regulation ECE 10 as last amended by series of amendments 06)

Tipo / Type:

Número total de páginas / Total number of pages:

7

Fecha / Date:

28/02/2020

IDIADA CN20030016



5. En el caso de componentes y unidades técnicas independientes, localización y método de fijación de la marca de homologación CE / *In the case of components and separate technical units, location and method of affixing of the EC approval mark:*
Stuck on the shell. See Drawings of the ESA.
6. Dirección(es) de la(s) planta(s) de montaje / *Address(es) of assembly plant(s):*
7. Nombre y dirección del solicitante / *Name and address of Applicant :*
8. Este SEE se homologará como componente/~~UTI~~⁽¹⁾ / *This ESA shall be approved as a component/~~STU~~⁽¹⁾*
9. Restricciones de uso y condiciones de instalación / *Any restrictions of use and conditions for fitting:*
N/A
10. Tensión nominal del sistema eléctrico / *Electrical system rated voltage:*
12V/24V, Negative ground.
Possible range for normal operation 10-30V, Negative ground.

(1) Táchese lo que no proceda / Delete where not applicable.



GENERALIDADES / GENERAL

1. Marca (razón social) / *Make (trade name of manufacturer):*



2. Tipo / *Type:*

Type _____ ; has variants as below:

The above variants have the same circuit design, wiring diagrams and components except appearance and LED quantity.

Denominación(es) comercial (es) / *General commercial description(s):*
LED auto light

3. Medio de identificación del tipo de componente o unidad técnica Independiente, si está marcado en los mismos ^(a) / *Means of identification of type, if marked on the component/separate technical unit ^(a):*
Approval mark
- 3.1. Emplazamiento de estas marcas / *Location of that marking:*
Stuck on the shell, See Drawings of the ESA
4. Nombre y dirección del fabricante / *Name and address of manufacturer:*

Nombre y dirección del representante autorizado (si procede) / *Name and address of authorised representative, if any:*

N/A

a) Si el medio de identificación del tipo contiene caracteres no pertinentes para la descripción del componente o unidad técnica independiente a que se refiere esta ficha, tales caracteres se sustituirán en la documentación por el signo «?» (ejemplo: ABC??123??) / *If the means of identification of type contains characters not relevant to describe the component or separate technical unit types covered by this information document, such characters shall be represented in the documentation by the symbol '?' (e.g. ABC??123??).*



Lista de componentes del SEE / List of components constituting the ESA
Marca y tipo de microprocesador, cristal, etc. / Make and type of microprocessor,
crystal, etc.

No	Component	Specification	Quantity
1	U1, U2, U3	TP8005	3
2	L1, L2, L3, L4	120uH	4
3	D1, D2, D3, D4, D5, D6	SS36	6
4	CX1	0.47uF	1
5	TVS1	SMAJ33A	1
6	CE1	47uF	1
7	Ci1, Ci2, Ci3	4.7uF	3
8	LED	LED1, LED2, LED3, LED4, LED5, LED6, LED7, LED8, LED9, LED10, LED11, LED12, LED13, LED14, LED15, LED16	16



Planos del SEE / Drawings of the ESA

Localización de la marca de homologación CE / Location of the EC approval mark

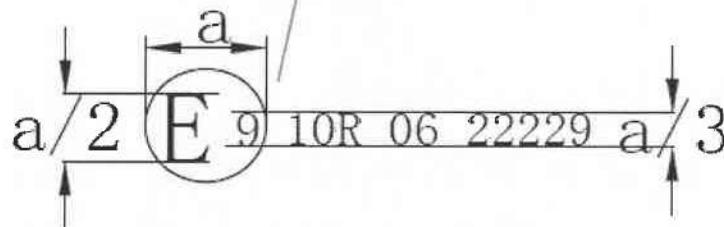

$$a \geq 6\text{mm min}$$





Diagrama de bloques electrónicos / *Electronic block diagram*



Shenzhen BCTC Technology Co.,Ltd.
NO.101,Yousong Road,Longhua New District,
Shenzhen,Guangdong P.R.China

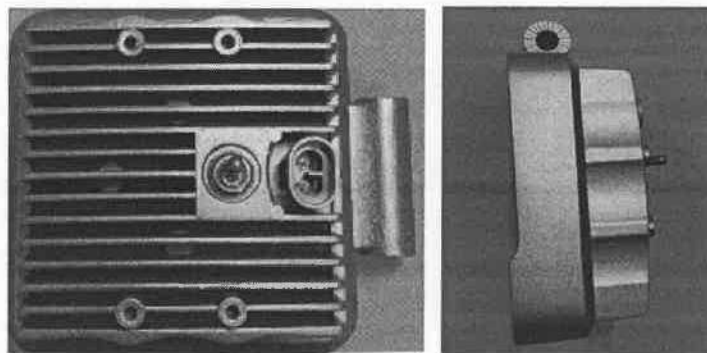
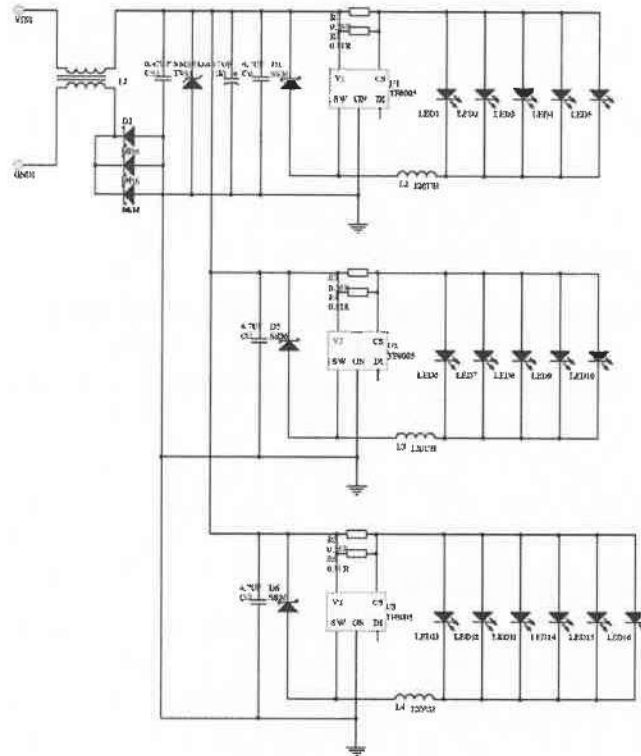

Certificate of Compliance

Certificate Number: BCTC-151114286

Applicant :

Manufacturer :

Product : LED AUTO LIGHT

M/N :
M FQ1648
M FQ927
M FR1545
M FT927

Test Standard : DIN 40050-9:1993

The EUT described above has been tested by us with the listed standard and found in compliance with the standard. It is possible to use IP69K marking to demonstrate the compliance with this standard. It is only valid in connection with the test report number: BCTC-151114286.

IP69K



This certificate of conformity is based on a single evaluation of the submitted sample(s) of the above mentioned product. It does not imply an assessment of the whole product and relevant. Directives have to be observed.

Tel: 400-788-9558 0755-33019988 [Http://www.bctc-lab.com](http://www.bctc-lab.com) [Http://www.btc-lab.com](http://www.btc-lab.com)

Shenzhen BCTC Technology Co.,Ltd.
NO.101,Yousong Road,Longhua New District,
Shenzhen,Guangdong P.R.China



Certificate of Compliance

Certificate Number: BCTC-151114283

Applicant :

Manufacturer :

Product : LED AUTO LIGHT

M/N :
M FQ927
M FT927
M FQ1648
M FR1545

Test Standard : EN 55015:2013
EN 61000-3-2:2014, EN 61000-3-3:2013
EN 61547:2009
EN 61000-4-2:2009, EN 61000-4-3: 2006+A1:2008+A2:2010
EN 61000-4-4:2012, EN 61000-4-5:2014
EN 61000-4-6:2014, EN 61000-4-8:2010, EN 61000-4-11:2004

The EUT described above has been tested by us with the listed standards and found in compliance with the council EMC directive 2014/30/EU. It is possible to use CE marking to demonstrate the compliance with this EMC Directive. It is only valid in connection with the test report number: BCTC-151114283.



This certificate of conformity is based on a single evaluation of the submitted sample(s) of the above mentioned product. It does not imply an assessment of the whole product and relevant Directives have to be observed.

Tel: 400-788-9558 0755-33019988 [Http://www.bctc-lab.com](http://www.bctc-lab.com) [Http://www.btc-lab.com](http://www.btc-lab.com)

Shenzhen BCTC Technology Co.,Ltd.
NO.101,Yousong Road,Longhua New District,
Shenzhen,Guangdong P.R.China



Certificate of Compliance

Certificate Number: BCTC-151114285

Applicant :

Manufacturer :

Product : LED AUTO LIGHT

M/N :
M FQ927
M FT927
M FQ1648
M FR1545

Test Standard : EN60529:1991+A1:2000+A2:2013

The EUT described above has been tested by us with the listed standards and found in compliance with the council LVD directive 2014/35/EU. It is possible to use IP marking to demonstrate the compliance with this LVD Directive. It is only valid in connection with the test report number: BCTC-151114285.

IP67



This certificate of conformity is based on a single evaluation of the submitted sample(s) of the above mentioned product. It does not imply an assessment of the whole product and relevant. Directives have to be observed.

Tel: 400-788-9558 0755-33019988 [Http://www.bctc-lab.com](http://www.bctc-lab.com) [Http://www.btc-lab.com](http://www.btc-lab.com)

Shenzhen BCTC Technology Co.,Ltd.
NO.101,Yousong Road,Longhua New District,
Shenzhen,Guangdong P.R.China



Certificate of Compliance

Certificate Number: BCTC-151114284

Applicant :

Manufacturer :

Product : LED AUTO LIGHT

M/N :
M FQ1648
M FQ927
M FR1545
M FT927

Test Standard : IEC62321-1:2013

The EUT described above has been consolidated by us and found in compliance with the council RoHS directive—2011/65/EU. It is possible to use CE marking to demonstrate the compliance with this RoHS Directive.



Manager

Nov. 25, 2015

This certificate of conformity is based on a single evaluation of the submitted sample(s) of the above mentioned product. It does not imply an assessment of the whole product and relevant. Directives have to be observed.

Tel: 400-788-9558 0755-33019988 [Http://www.bctc-lab.com](http://www.bctc-lab.com) [Http://www.btc-lab.com](http://www.btc-lab.com)